

* -

HunterDouglas 
Architectural

Drwg.No. C-i-Me-PI-Alpha -Bandraster Swingdown -2D_Application A	Date: 19.07.2019	Scale: 1:5
	Size: A3	Rev: -
Subject: Ceiling Interior Metal Planks Alpha Bandraster Swingdown		

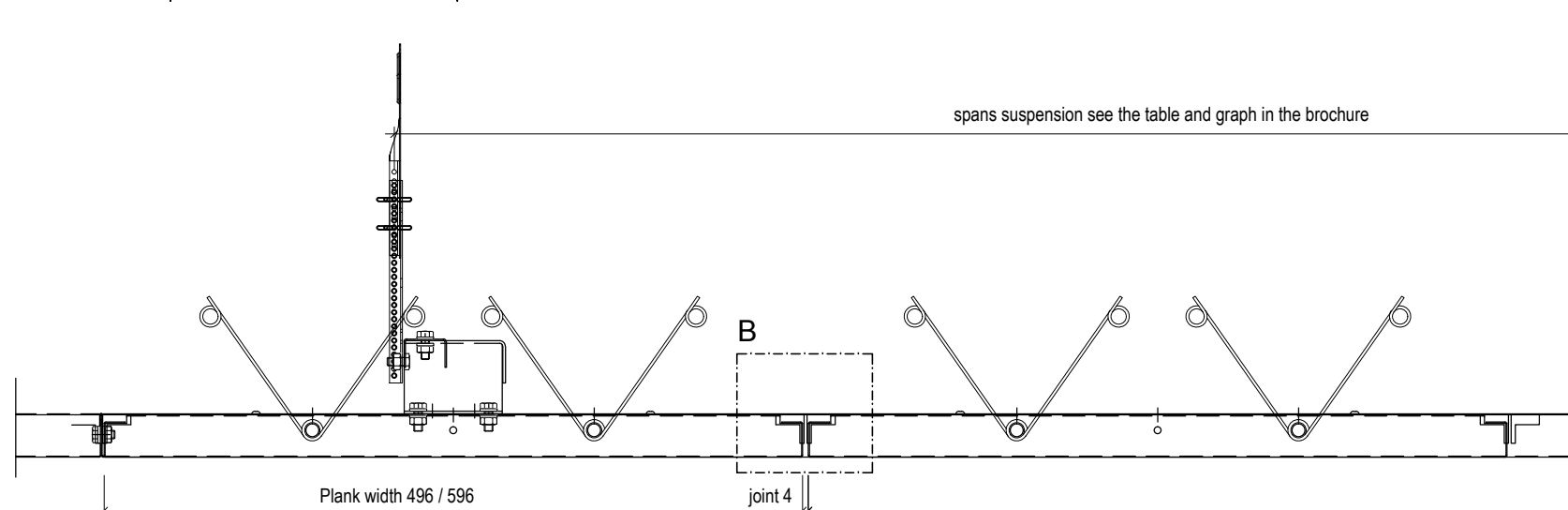
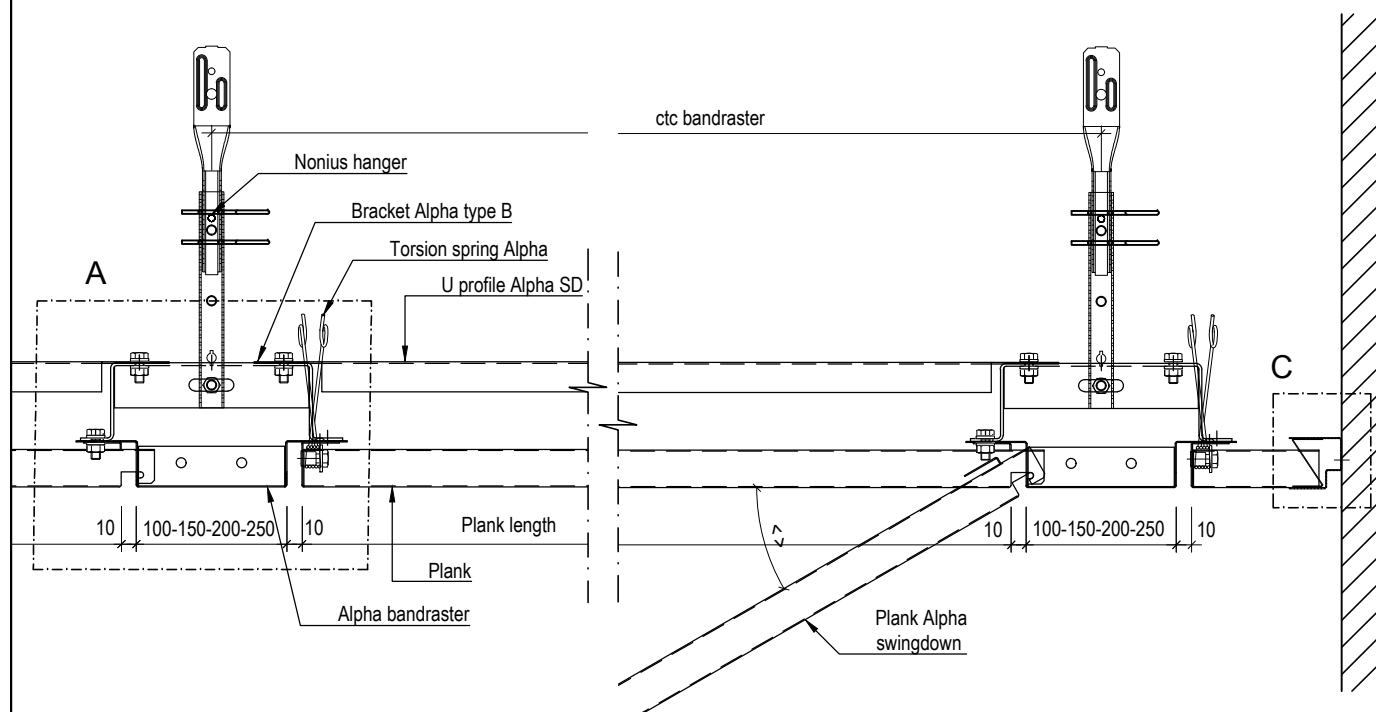
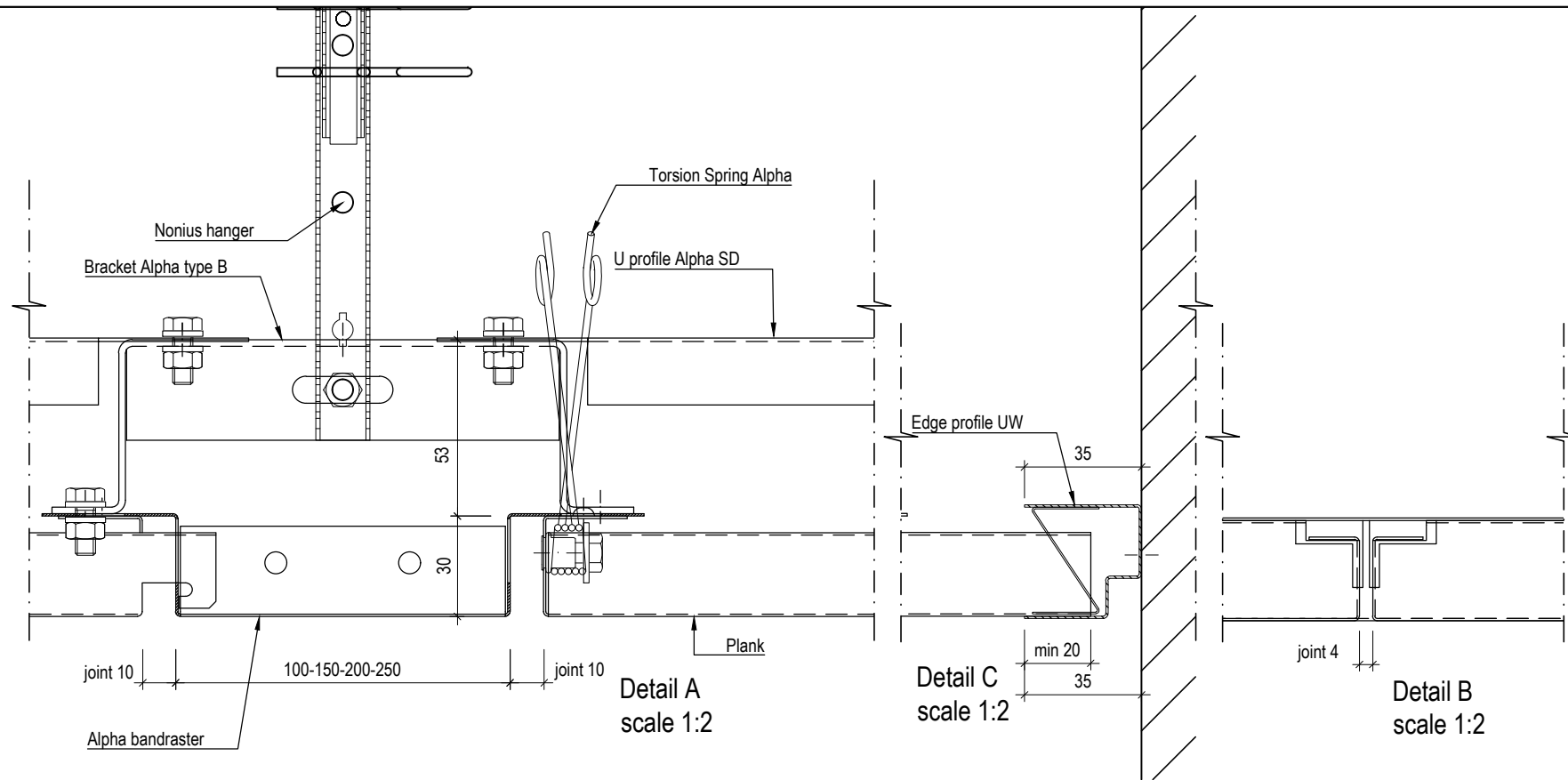
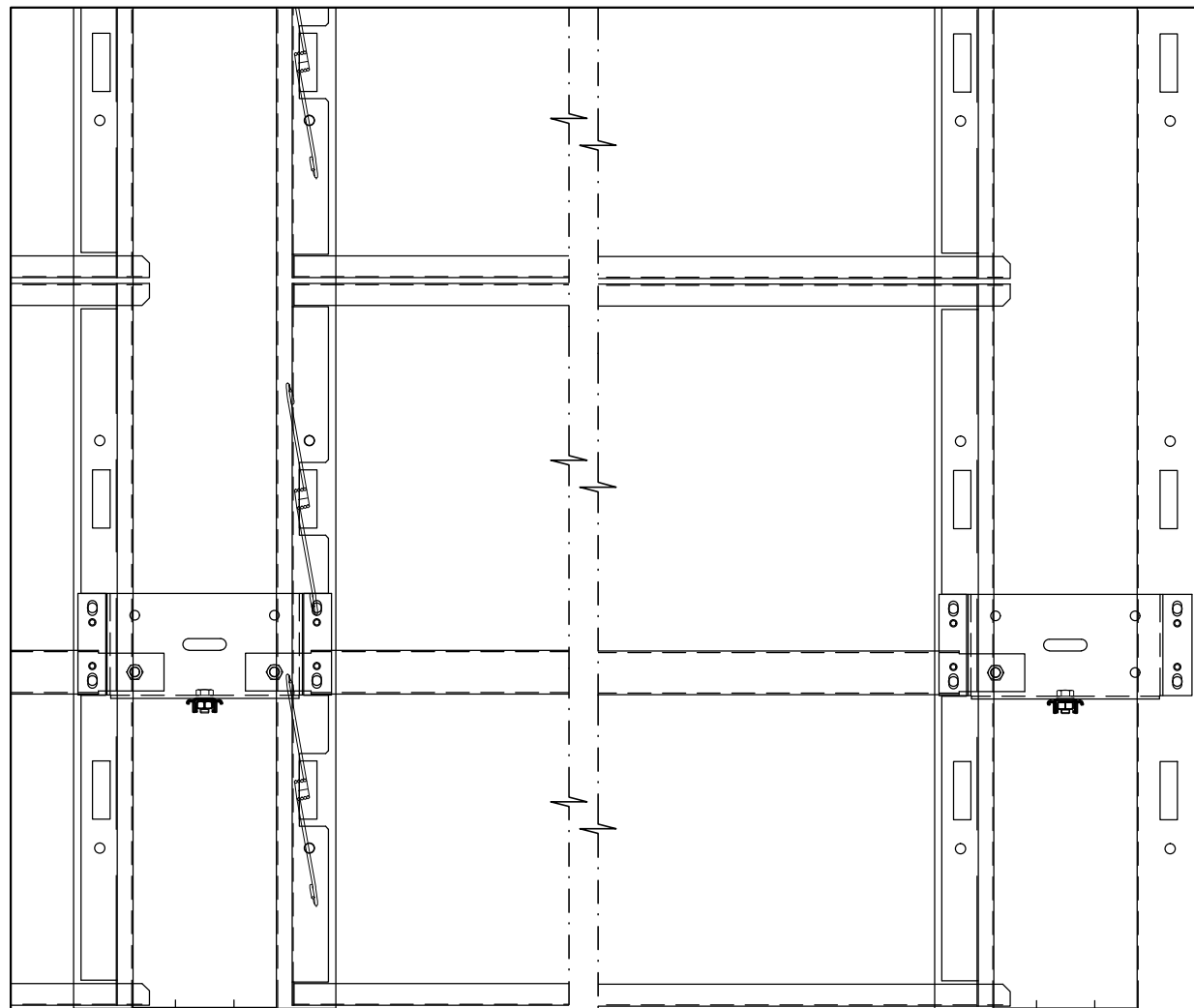

* -

HunterDouglas 
Architectural

Drwg.No. C-i-Me-PI-Alpha -Bandraster Swingdown -2D_Application B	Date: 22.07.2019	Scale: 1:5
	Size: A3	Rev: -
Subject: Ceiling Interior Metal Planks Alpha Bandraster Swingdown		

**Plank Alpha bandraster
SD 300 AI / Fe**

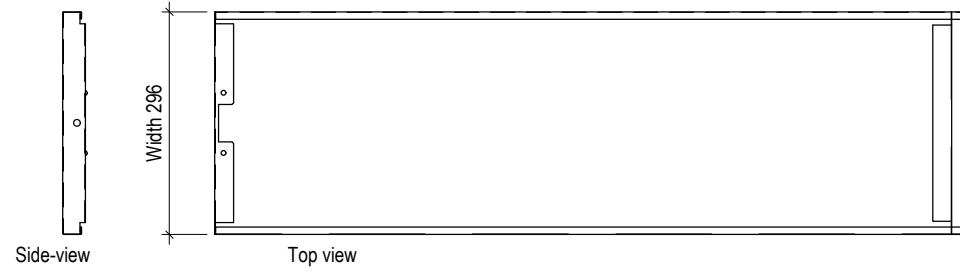

**Plank Alpha bandraster
SD 400 AI / Fe**

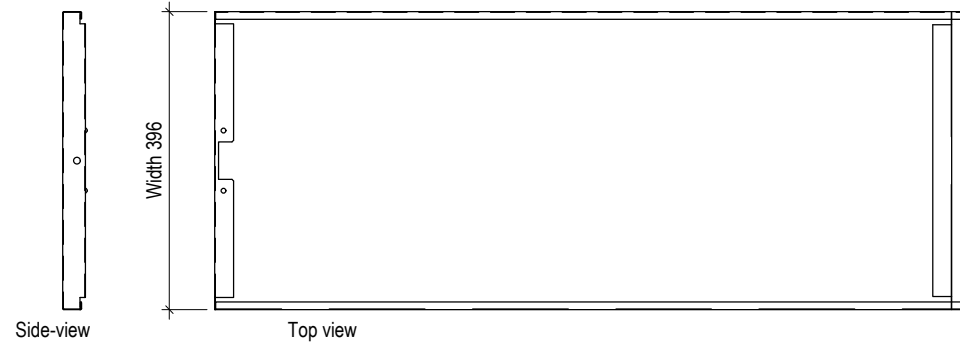

**Plank Alpha bandraster
SD 500 AI / Fe**

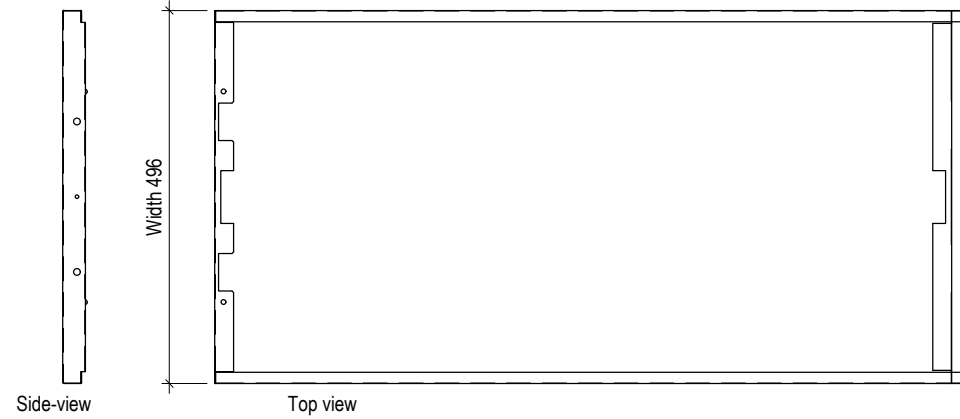

**Plank Alpha bandraster
SD 600 AI / Fe**

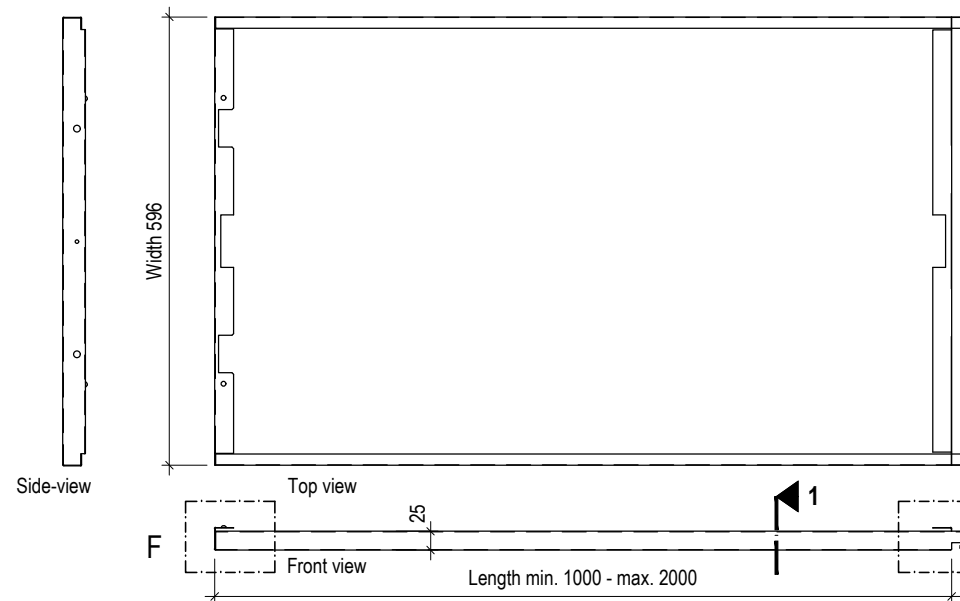

PERFORATION PATTERNS scale 1:1

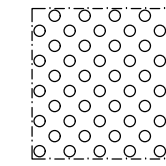

D1522
φ 1,5 mm
↑ 4 mm ↔ 4 mm
Openness 22 %

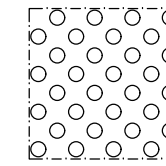

D2022
φ 2 mm
↑ 5 mm ↔ 5 mm
Openness 22 %

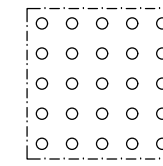

D1511
φ 1,5 mm
↑ 4 mm ↔ 4 mm
Openness 11 %

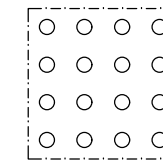

D2011
φ 2 mm
↑ 5 mm ↔ 5 mm
Openness 11 %

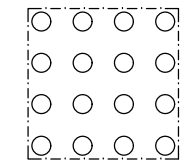

D2516
φ 2,5 mm
↑ 5,5 mm ↔ 5,5 mm
Openness 16 %

**Section 1
scale 1:1**

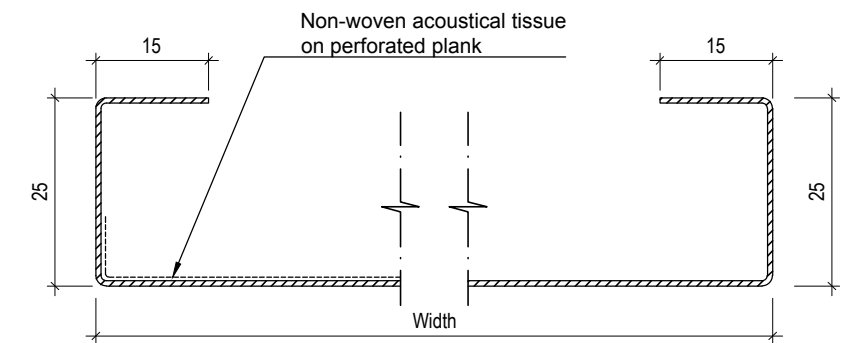

Width from	Width to	Length from	Length to	Height
300	400	1000	2400	25
500	600	1000	2000	25

